

Article number: 2310310341ESD

Description: E+G Antistatic base for levelling elements
LV.A-125-24-AS-M20x138-ESD-C

Measures

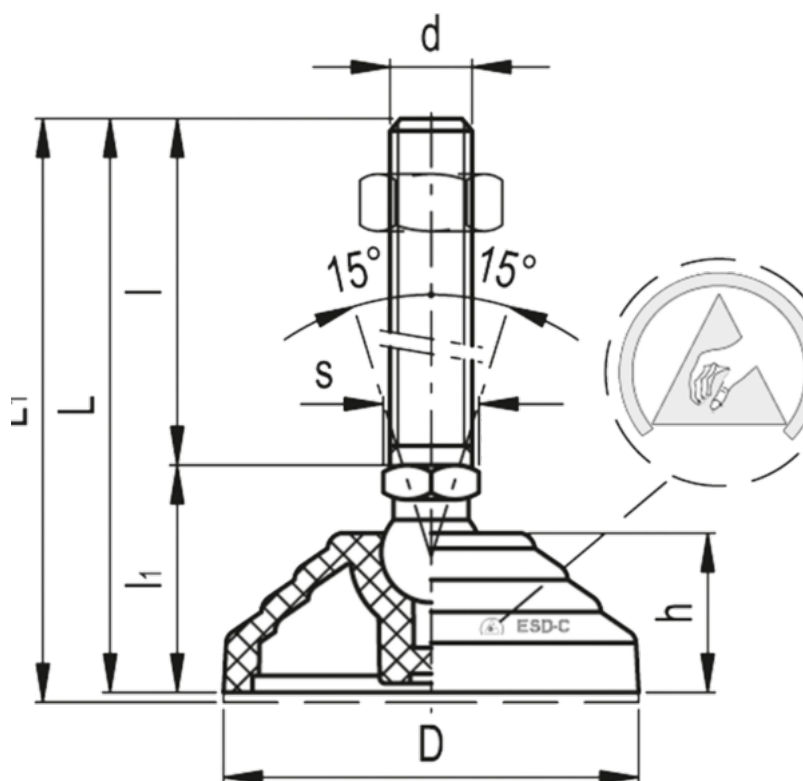

Articulation = 24	Max load = 28000
D = 125	s = 24
d = M20	Weight in (g) = 712
h = 46	
l = 138	
l1 = 67	
L = 205	
L1 = 208	